

BlueStar's Precious Metals line combines power and high-performance with unique cooking features and aesthetic sensibilities inspired by one of the world's leading chefs.



PRODUCT FEATURES

- UltraNova™ power burner delivers 22,000 BTUs of intense heat
- Integrated cooktop options include griddles, charbroilers and French tops
- Gentle 130° simmer burner
- Extra-large convection oven that accommodates a full size 18" x 26" commercial baking sheet
- 1850° Infrared broiler
- Available in 6 unique colors or 750+ options
- Colored knobs & trim to match the range color
- Dependent French doors allow for easy loading/unloading

SPECIFICATIONS

Range Dimensions: 35.875"W x 24"D x 36.75"H
 Oven Interior: 29"W x 20"D x 15"H
 Top Burner Rating: 22,000 BTUs
 Simmer Burner Rating: 9,000 BTUs
 French Top Burner Rating: 18,000 BTUs
 Large Oven Burner Rating: 30,000 BTUs
 Infrared Broiler Rating: 15,000 BTUs
 Electrical Requirements: 120V, 60Hz, 15 AMPs, 1 PH
 (Unit must be on a Non-GFI, dedicated outlet)
 Operating Gas Pressure: NAT: 5.0" WC, LP: 10.0" WC
 Gas Line Size: 3/4"
 Installation Clearance: 0" Side Cabinet, 0" Back Wall

MODEL CONFIGURATION

Four Burners RNB364FTPMV2
 with 12" French Top

BURNER CONFIGURATION

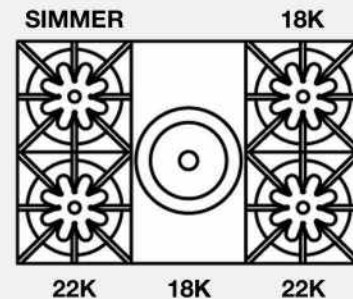

ADDITIONAL CUSTOMIZATION OPTIONS

- Burner configurations
- Integrated cooktop options
- Knob colors
- Trim options

*All specifications subject to change without notice.
 Contact BlueStar Customer Service at (800) 449 - 8691
 prior to installation or site preparation.*

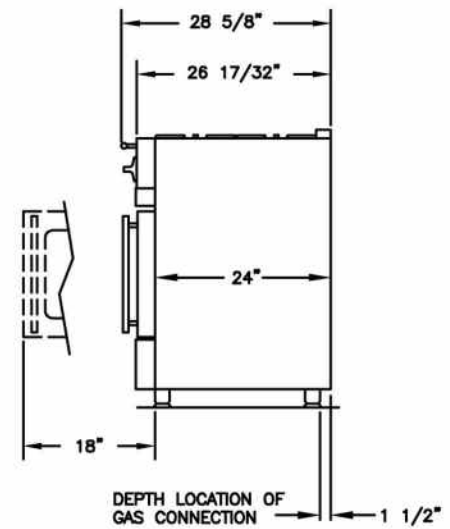
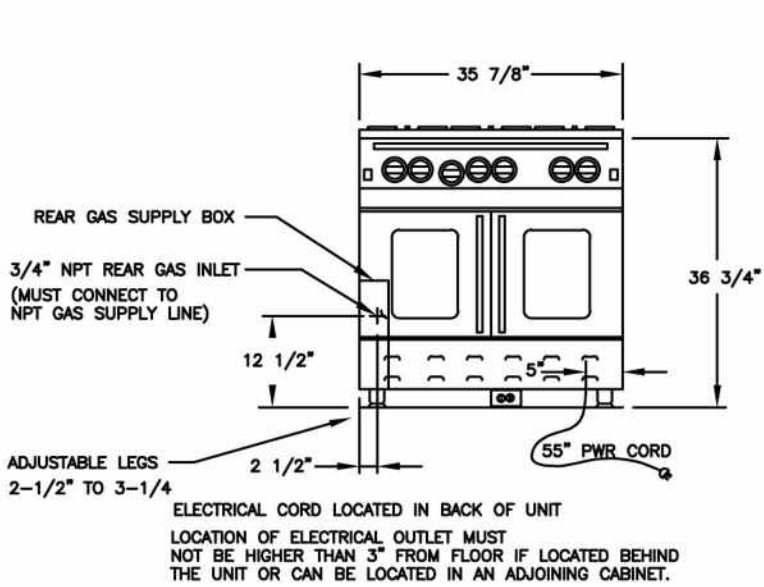

RELATED PRODUCTS

VENTILATION



SALAMANDER BROILER

