

New features found only on the Platinum Series offer unsurpassed power and performance for discerning home chefs who demand restaurant-quality results.

PRODUCT FEATURES

- PrimaNova™ power burner delivers 25,000 BTUs of intense heat
- All burners including Interchangeable Griddle and Charbroiler
- Gentle 130° simmer burner
- New PowR Oven™ provides 40% faster preheating and 30% increase in oven efficiency
- Extra-large oven with True European Convection 1850° Infrared Broiler
- Accommodates full-size commercial 18" x 26" baking sheet
- Available in 750+ colors and finishes

SPECIFICATIONS

Range Dimensions: 35.875"W x 24"D x 36.75"H
 Oven Interior: 29"W x 20"D x 15"H
 Top Burner Rating: 25,000 BTUs
 Simmer Burner Rating: 9,000 BTUs
 PowR Oven™ Burner Rating: 25,000 BTUs
 Infrared Broiler Rating: 15,000 BTUs
 Electrical Requirements: 120V, 60Hz, 15 AMPs, 1 PH
 (Unit must be on a Non-GFI, dedicated outlet)
 Operating Gas Pressure: NAT: 5.0" WC, LP: 10.0" WC
 Gas Line Size: 3/4"
 Installation Clearance: 0" Side Cabinet, 0" Back Wall



MODEL CONFIGURATION

Six Burners with Interchangeable Griddle Charbroiler **BSP366B**

BURNER CONFIGURATION

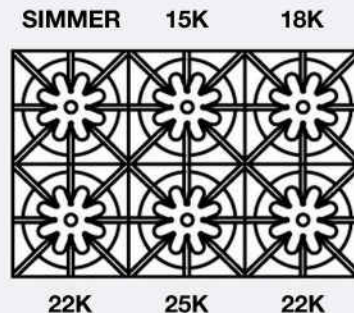

ADDITIONAL CUSTOMIZATION OPTIONS

- Burner configurations
- Backguards
- Knob colors
- Trim options

All specifications subject to change without notice. Contact BlueStar Customer Service at (800) 449 - 8691 prior to installation or site preparation.

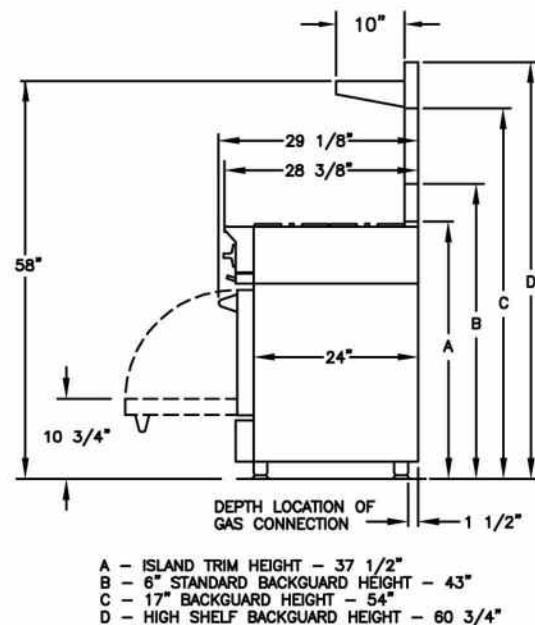
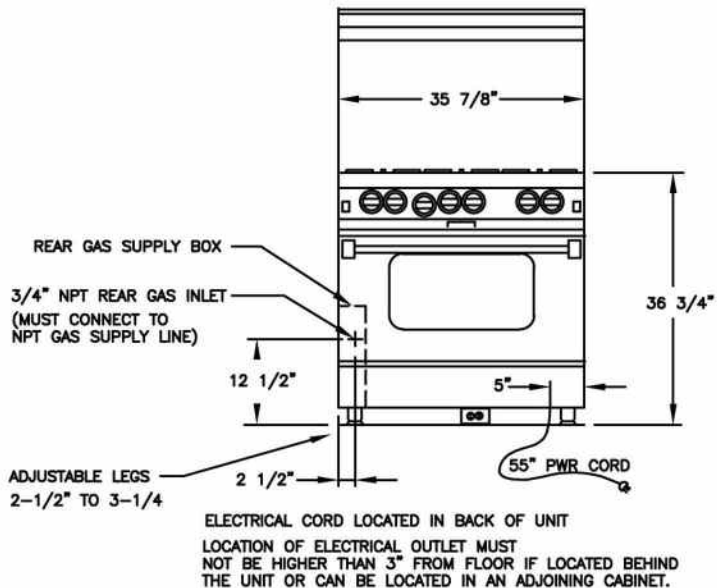

RELATED PRODUCTS

VENTILATION



SALAMANDER BROILER

