

BlueStar® has combined professional level features and a sleek design into its new Sealed Burner Series. Cook like a pro with professional level power and versatility with up to 21,000 BTUs* of searing power plus a precise simmer burner. The Sealed Burner Series features an extra-large convection oven that will accommodate a commercial size baking sheet.

PRODUCT FEATURES

- 4 sealed burners for maximum cooking area
- Powerful 21,000* BTU burners
- Precise 5,000 BTU simmer burner
- Convection oven fits commercial size sheet pans
- 1850° commercial-grade infrared broiler
- Available in 1,000+ colors and finishes plus 10 metal trims
- Handcrafted in Pennsylvania since 1880

SPECIFICATIONS

Range Dimensions: 29.875"W x 24"D x 36.75"H
 Oven Interior: 23.25"W x 20"D x 15"H
 Top Burner Rating: Nat: 21,000 BTUs | LP: 18,000 BTUs*
 (* LP units have max burner power of 18,000 BTUs)
 Simmer Burner Rating: 5,000 BTUs
 Large Oven Burner Rating: 30,000 BTUs
 Infrared Broiler Rating: 15,000 BTUs
 Electrical Requirements: 120V, 60Hz, 15 AMPs, 1 PH
 (Unit must be on a Non-GFI, dedicated outlet)
 Operating Gas Pressure: NAT: 5.0" WC, LP: 10.0" WC
 Gas Line Size: 1/2"
 Installation Clearance: 0" Side Cabinet, 0" Back Wall



MODEL CONFIGURATION

Four Burners

RCS30SBV2

BURNER CONFIGURATION

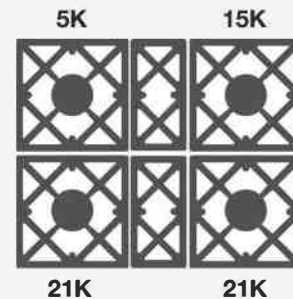

ADDITIONAL CUSTOMIZATION OPTIONS

- 1,000 colors and finishes
- 190 knob colors
- 10 metal trims
- Backguard options

*All specifications subject to change without notice.
 Visit www.bluestarcooking.com prior to installation
 or site preparation.*

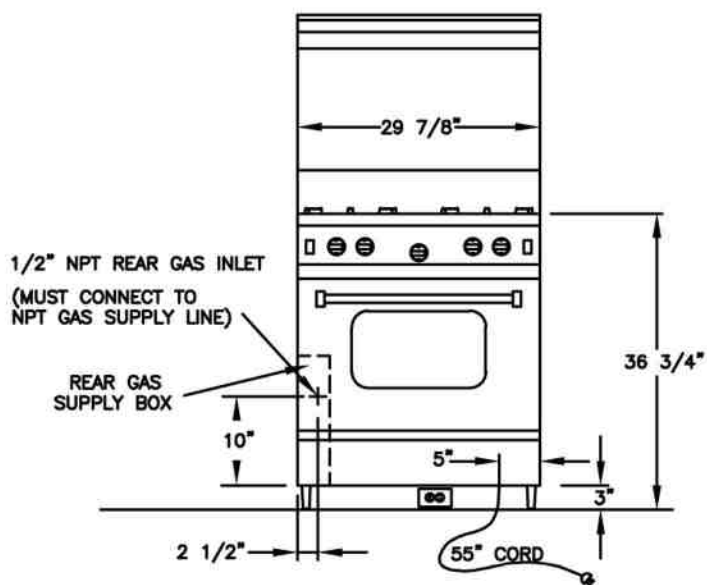

ELECTRICAL CORD LOCATED IN BACK OF UNIT
LOCATION OF ELECTRICAL OUTLET MUST NOT BE HIGHER THAN 3" FROM FLOOR IF LOCATED BEHIND THE UNIT OR CAN BE LOCATED IN AN ADJOINING CABINET.

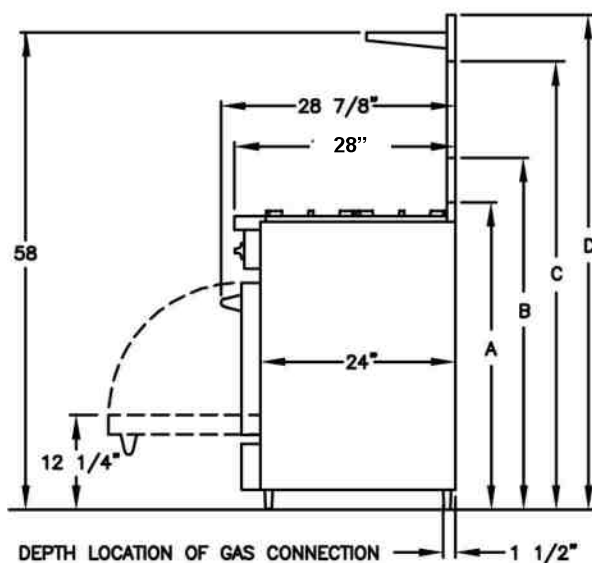

- A - ISLAND TRIM HEIGHT - 38 1/4"
- B - 6" STANDARD BACKGUARD HEIGHT - 43 1/4"
- C - 17" BACKGUARD HEIGHT - 54 1/4"
- D - HIGH SHELF BACKGUARD HEIGHT - 61"

RELATED PRODUCTS

VENTILATION

