

The newly redesigned RNB Series features restaurant quality performance and nearly unlimited customization options. BlueStar's most customizable line, the RNB Series is available with integrated griddles, charbroilers, French tops and swing doors plus your choice of over 1,000+ colors.

PRODUCT FEATURES

- UltraNova™ power burner delivers 22,000 BTUs of intense heat
- Integrated cooktop options include griddles, charbroilers and French tops
- Gentle 130° simmer burner
- Extra-large convection oven that accommodates a full size 18" x 26" commercial baking sheet
- 1850° Infrared broiler
- Available in 1,000+ colors and finishes
- 24" depth for compatibility with standard kitchen cabinetry

SPECIFICATIONS

Range Dimensions: 47.875"W x 24"D x 36.75"H

Large Oven Interior: 23.25"W x 20"D x 15"H

Small Oven Interior: 13.25"W x 20"D x 15"H

Top Burner Rating: 22,000 BTUs

Simmer Burner Rating: 9,000 BTUs

12" Charbroiler Rating: 15,000 BTUs

Large Oven Burner Rating: 30,000 BTUs

Small Oven Burner Rating: 15,000 BTUs

Infrared Broiler Rating: 15,000 BTUs

Electrical Requirements: 120V, 60Hz, 15 AMPs, 1 PH
(Unit must be on a Non-GFI, dedicated outlet)

Operating Gas Pressure: NAT: 5.0" WC, LP: 10.0" WC

Gas Line Size: 3/4"

Installation Clearance: 0" Side Cabinet, 0" Back Wall



MODEL CONFIGURATION

Six Burners

RNB486CBV2

with 12" Charbroiler

BURNER CONFIGURATION

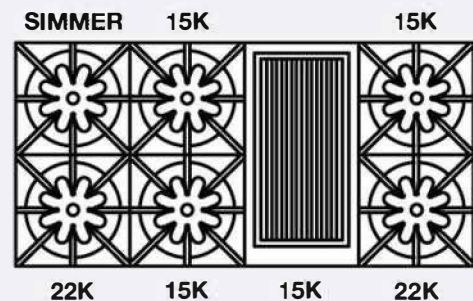

ADDITIONAL CUSTOMIZATION OPTIONS

- Burner configurations
- Integrated cooktop options
- Door options
- Backguards
- Knob colors
- Trim options

*All specifications subject to change without notice.
Contact BlueStar Customer Service at (800) 449 - 8691
prior to installation or site preparation.*

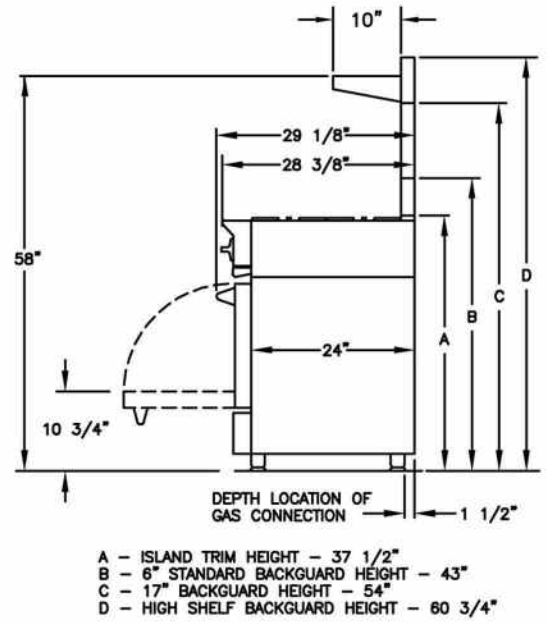
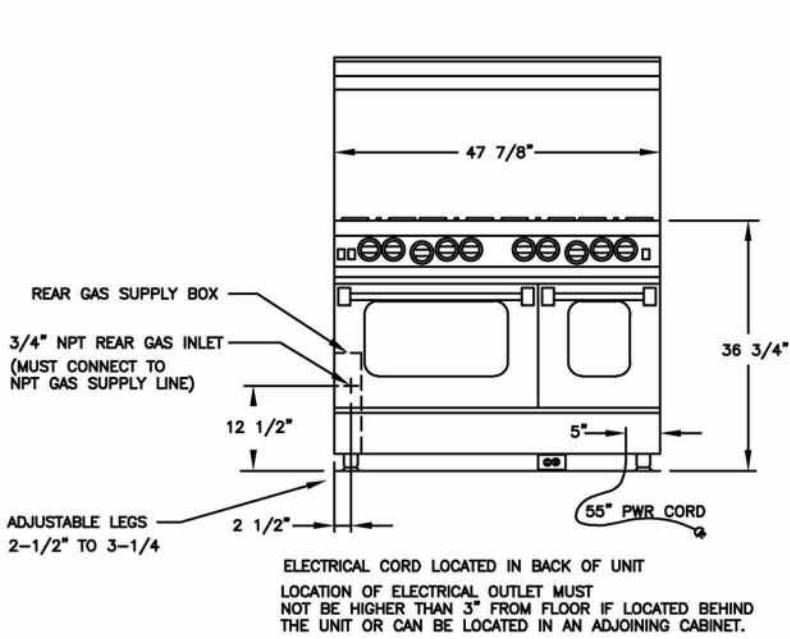

RELATED PRODUCTS

VENTILATION



SALAMANDER BROILER

