

The newly redesigned RNB Series features restaurant quality performance and nearly unlimited customization options. BlueStar's most customizable line, the RNB Series is available with integrated griddles, charbroilers, French tops and swing doors plus your choice of over 1,000+ colors.



PRODUCT FEATURES

- UltraNova™ power burner delivers 22,000 BTUs of intense heat
- Integrated cooktop options include griddles, charbroilers and French tops
- Gentle 130° simmer burner
- Extra-large convection oven that accommodates a full size 18" x 26" commercial baking sheet
- 1850° Infrared broiler
- Available in 1,000+ colors and finishes
- Refined design and easier-to-clean cooktop
- 24" depth for compatibility with standard kitchen cabinetry

SPECIFICATIONS

Range Dimensions: 59.875"W x 24"D x 36.75"H
 Oven Interior: 26.25"W x 20"D x 15"H
 Top Burner Rating: 22,000 BTUs
 Simmer Burner Rating: 9,000 BTUs
 Large Oven Burner Rating: 30,000 BTUs
 Infrared Broiler Rating: 15,000 BTUs
 Electrical Requirements: 120V, 60Hz, 15 AMPs, 1 PH
 (Unit must be on a Non-GFI, dedicated outlet)
 Operating Gas Pressure: NAT: 5.0" WC, LP: 10.0" WC
 Gas Line Size: 3/4"
 Installation Clearance: 0" Side Cabinet, 0" Back Wall

MODEL CONFIGURATION

Ten Burners

RNB6010BV2

BURNER CONFIGURATION

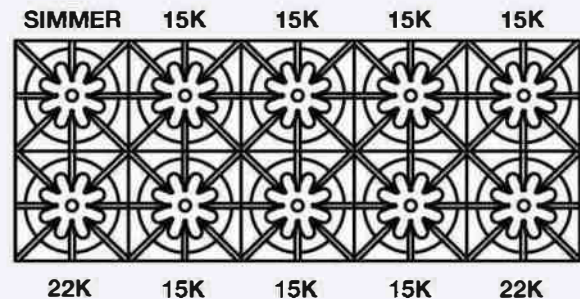

ADDITIONAL CUSTOMIZATION OPTIONS

- Burner configurations
- Integrated cooktop options
- Door options
- Backguards
- Knob colors
- Trim options

*All specifications subject to change without notice.
 Contact BlueStar Customer Service at (800) 449 - 8691
 prior to installation or site preparation.*

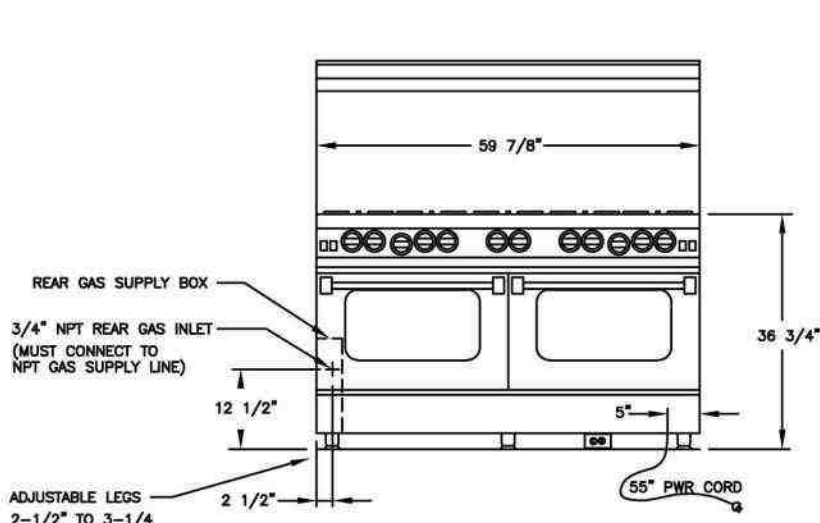

ELECTRICAL CORD LOCATED IN BACK OF UNIT
 LOCATION OF ELECTRICAL OUTLET MUST NOT BE HIGHER THAN 3" FROM FLOOR IF LOCATED BEHIND THE UNIT OR CAN BE LOCATED IN AN ADJOINING CABINET.

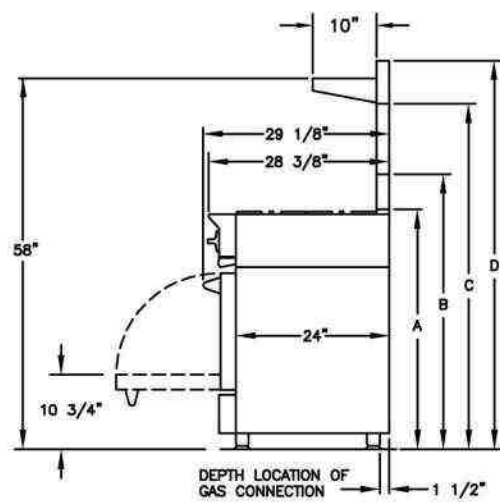

A - ISLAND TRIM HEIGHT - 37 1/2"
 B - 6" STANDARD BACKGUARD HEIGHT - 43"
 C - 17" BACKGUARD HEIGHT - 54"
 D - HIGH SHELF BACKGUARD HEIGHT - 60 3/4"

RELATED PRODUCTS

VENTILATION



SALAMANDER BROILER

