

# USE & CARE MANUAL



# BLUESTAR<sup>®</sup>

TOUCH  
Induction Cooktop

701122

# BlueStar® TOUCH Induction Cooktop

## Model BSP36INDTOUCH

This appliance was designed for ease of installation and operation. However, we recommend that you read all section of this manual before your begin installation and use.

Do not remove permanently affixed labels, warnings or data plates from your appliance. This may void the manufacturer's warranty and/or hinder effective servicing and maintenance.

Keep these instructions with the appliance and retain them for future reference.

### **WARNING!**

**If the information in this manual is not followed exactly, a fire or explosion and or shock may result causing property damage, personal injury or death. FOLLOW ALL NATIONAL ELECTRICAL CODES, STATE AND OR LOCAL CODES THAT APPLY TO ELECTRICAL APPLIANCES.**



**Do not store or use gasoline or other flammable vapors and liquids in the vicinity of this or any other appliance.**

#### **WHAT TO DO IF YOU SMELL WIRE BURNING**

**Do not try to activate any appliance.**

**Do not touch or activate any electrical switch.**

**Disconnect the unit by turning off the circuit breaker or fuse.**

**If smell continues or increases, contact the fire department.**

**Installation and service must be performed by a qualified installer or service agency.**

**DANGER  
ELECTRICAL SHOCK HAZARD**

## IMPORTANT SAFETY INSTRUCTIONS

### SAVE THESE INSTRUCTIONS

Read all instructions before using your appliance. Follow these important safety precautions to reduce the risk of fire, electric shock, personal injury or property damage.

Do not remove permanent labels, warnings or data plates including the serial number from your appliance. Removal may void the manufacturer's warranty and/or hinder effective servicing and maintenance.



If the information in this manual is not followed exactly, a fire or explosion may result causing property damage, personal injury or death.

- Proper Installation - Your appliance should be properly installed and grounded by a qualified electrical installation technician. Ask the technician to show you the exact location of the circuit breaker and / or fuse on the incoming electrical panel so you know how to turn off the electricity if necessary.
- Never use your appliance for warming or heating the room.
- Do Not Leave Children Alone – Children should not be left alone or unattended in the area where the appliance is in use. They should never be allowed to sit or stand on any part of the appliance.
- User Servicing - Do not repair or replace any part of this appliance unless specifically recommended in this manual. All other servicing should be referred to a qualified technician. In-warranty service must be completed by an authorized service agency.
- Do not store flammable materials in, on, or near the appliance. Keep the appliance area clean and free of combustible materials, gasoline and other flammable vapors and liquids, aerosol and sealed containers like baby food jars. Check before each use to make sure that no hazardous materials are in the area.
- Do Not Use Water on Grease Fires – Smother fire or flame or use dry chemical or foam-type extinguisher.
- Use Only Dry Potholders – Moist or damp potholder on hot surfaces may result in burns from steam. Do not let potholder touch hot heating elements. Do not use a towel or other bulky cloth.
- Disconnect the appliance from the electric supply before any maintenance or repairs.
- In the event of a power failure, the unit will shut off. Do not attempt to operate the appliance.
- Keep the ventilation of this appliance unobstructed at all times.
- All local and national codes and ordinances must be observed. Installation must conform to the local codes.
- In Canada: Installation must be in accordance with the current local code.

# IMPORTANT SAFETY INSTRUCTIONS

SAVE THESE INSTRUCTIONS



FOLLOW THESE GUIDELINES FOR INDUCTION COOKING. FAILURE TO COMPLY MAY RESULT IN PERSONAL INJURY OR DAMAGE THE COOKTOP.

- **Cooking Utensils** – Only ferromagnetic pans are suitable for induction cooking. These can be of enameled steel, cast iron, or special stainless steel utensils for induction cooking. Never use normal stainless steel glass, ceramic, copper or aluminum pans. If the base of your utensil is attracted to a magnet it is suitable.
- **Use Proper Pan Size** – This appliance is equipped with one or more surface units of different size. Select utensils having flat bottoms large enough to cover the surface unit heating element. The use of undersized utensils will expose a portion of the heating element to direct contact and may result in ignition of clothing. Proper relationship of utensil to heat zone will also improve efficiency.
- **Never Leave Surface Units Unattended at High Heat Settings** – Boilover causes smoking and greasy spillover that may ignite.
- **Protective Liners** – Do not use aluminum foil to line cooktop. Use of these liners may result in a risk of electric shock, or fire.
- **Utensil Handles Should Be Turned Inward and Not Extend Over Adjacent Surface Units** – To reduce the risk of burns, ignition of flammable materials, and spillage due to unintentional contact with the utensil, the handle of a utensil should be positioned so that it is turned inward.
- **Do Not Cook on a Broken Cooktop** – If the ceramic cooktop breaks, cracks or becomes pitted, cleaning solutions and spillover may penetrate the broken cooktop and create a risk of electric shock. Unplug the appliance and contact a qualified technician immediately.
- **Clean Cooktop with Caution** – If a wet sponge or cloth is used to wipe spills on a hot cooking area, be careful to avoid steam burn. Some cleaners can produce noxious fumes if applied to a hot surface.
- **Do not place metallic objects such as knives, forks, spoons and lids on the cooktop surface since they can get hot.**
- **If the malfunction light **E** is displayed, the cooktop is malfunctioning. Turn off or disconnect appliance from power supply. Contact a qualified technician for service.**

# IMPORTANT SAFETY INSTRUCTIONS

SAVE THESE INSTRUCTIONS



FOLLOW THESE GUIDELINES FOR INDUCTION COOKING. FAILURE TO COMPLY MAY RESULT IN PERSONAL INJURY OR DAMAGE THE COOKTOP.

## **Electromagnetic interference**

This induction cooktop generates and uses ISM frequency energy that heats cookware by using an electromagnetic field. It has been tested and complies with Part 18 of the FCC Rules for ISM equipment. This induction cooktop meets the FCC requirements to minimize interference with other devices in residential installation. Induction cooktops may cause interference with television or radio reception. If interference occurs, the user should try to correct the interference by:

- Relocating the receiving antenna of the radio or television.
- Increasing the distance between the cooktop and the receiver.
- Connecting the receiver into an outlet different than the receiver.
- It is the user's responsibility to correct any interference.

## **CAUTION**

Persons with a pacemaker or similar medical device should exercise caution when standing near an induction cooktop while it is in use. Consult your doctor or the manufacturer of the pacemaker or similar medical device for additional information about its effects with electromagnetic fields from an induction cooktop.

**THE USE OF POOR QUALITY POTS, PANS, OR COOKWARE, OR AN INDUCTION ADAPTOR PLATE/DISK FOR NON-MAGNETIC COOKWARE, IS A WARRANTY BREACH.**

**IN THESE CASES, BLUESTAR CANNOT BE HELD RESPONSIBLE FOR ANY DAMAGE CAUSED TO THE COOKTOP AND / OR ITS ENVIRONMENT.**

## IMPORTANT SAFETY INSTRUCTIONS

SAVE THESE INSTRUCTIONS



- **CAUTION** - Do not store items of interest to children in cabinets above or the backguard behind the appliance. Children climbing on the appliance to reach items could be seriously injured.
- **DO NOT TOUCH SURFACE UNITS OR AREAS NEAR UNITS** – Surface units may be hot even though they are dark in color. Areas near surface units may become hot enough to cause burns. During and after use, do not touch the cooktop or let clothing or other flammable materials contact the surface or areas near units until they have had sufficient time to cool. Among these areas are the cooktop and display panel.
- To eliminate the risk of burns or fire by reaching over heated surface units, cabinet storage space located above the surface units should be avoided. If cabinet storage is provided, the risk can be reduced by installing a range hood that projects horizontally a minimum of 5 inches beyond the bottom of the cabinets.
- Only persons familiar with oven operation should use it.
- Persons who lack physical, sensory or mental abilities, or experience with the appliance, should use the appliance with supervision.
- This appliance is designed for Residential Use Only.
- This appliance is not approved for outdoor use.
- Do not install if damaged. Do not operate if not working properly or if damaged.
- Disconnect from the power supply if there is an error display message.
- Children should not use the unit without supervision unless its operation has been sufficiently explained so they can safely operate it. Children must be able to recognize potential hazards or improper operation.
- Only use this appliance for the intended purposes described in this user manual.
- Do not sit, stand, or climb on any part of the appliance. Serious injury may occur.
- Never wear loose fitting clothing or garments with loose sleeves or strings while using this appliance. Tie hair back.
- Do not use a steam cleaner to clean the oven since the steam could penetrate electrical components and cause a short circuit.
- Keep pet birds out of the kitchen or other rooms where kitchen fumes could reach them.
- Keep operating instructions in a safe place and pass on to any future user.

# IMPORTANT SAFETY INSTRUCTIONS

SAVE THESE INSTRUCTIONS



IN THE EVENT OF FIRE, TAKE THE FOLLOWING STEPS TO PREVENT INJURY AND FIRE SPREADING

- Turn off the cooktop.
- Turn off any ventilation units.
- Do Not Use Water on Grease Fires – Smother fire or flame or use dry chemical or foam-type extinguisher.
- It is recommended you purchase a multi-purpose dry chemical or foam-type fire extinguisher for your home. Store it in close proximity to your appliance.

**Have a working smoke detector in or near the kitchen.**

## THANK YOU & WELCOME

Thank you for your purchase and welcome to the BlueStar® Family!

BlueStar® appliances are designed for discerning home chefs who demand restaurant-quality results in their own kitchens. As the owner of a new BlueStar® appliance you can look forward to years of culinary excellence. You will prepare meals with the speed and accuracy of a professional chef right in your own kitchen. All equipment is designed and manufactured to the highest quality standards in the industry specifically to meet the needs of the world's most demanding chef: you.

Please review and familiarize yourself with this Use & Care Guide which includes operating and cleaning instructions as well as tips for getting the most out of your appliance.

Since 1880, we have been handcrafting the highest quality ovens and ranges at our Pennsylvania factory. If your appliance ever needs attention, please be sure to use a BlueStar® certified service provider recommended by our sales service team. Our service team can be reached at 800-449-8691 Monday through Friday from 9 a.m. to 5 p.m. EST or [serviceteam@bluestarcooking.com](mailto:serviceteam@bluestarcooking.com).

Please take a few moments now to fill in the Service Information for your future reference. In the event you require parts or service, this information will be needed to ensure you receive the highest quality service we can provide.

We hope you enjoy your new induction cooktop,  
The BlueStar® Team

**PLEASE NOTE: ALL APPLIANCES SHOULD BE INSPECTED UPON ARRIVAL. PER THE WARRANTY ANY COSMETIC ISSUES MUST BE REPORTED TO YOUR DEALER WITHIN 7 DAYS OF DELIVERY. THE PERFORMANCE CHECKLIST MUST BE COMPLETED BY THE CERTIFIED INSTALLER WITHIN 15 DAYS OF INSTALLATION, AND SENT TO BLUESTAR®.**



## SERVICE INFORMATION

Date of Purchase

---

Model Number

---

Serial Number

---

Dealer Name

---

Dealer Phone

---

Dealer Address

---

Date of Installation

---

Installer Name

---

Installer Phone

---

Installer Address

---

**Your installer should complete the online Performance Checklist, found at [www.bluestarcooking.com](http://www.bluestarcooking.com) or the last page of this manual, before leaving your residence.**

**NOTE: WARRANTY SERVICE MUST BE PERFORMED BY AN AUTHORIZED SERVICE AGENT. YOU MAY REQUEST WARRANTY SERVICE BY CALLING-800 449-8691. YOU MAY ALSO REQUEST SERVICE FROM AN AUTHORIZED BLUESTAR DEALER AT [WWW.BLUESTARCOOKING.COM/SUPPORT](http://WWW.BLUESTARCOOKING.COM/SUPPORT)**

## GETTING STARTED

We know you are excited to start using your new BlueStar® appliance. Before you begin, it is essential that you follow these steps for safe and optimal use.

- Read this manual in its entirety and keep near your appliance.
- Become familiar with all the parts of your appliance.
- Remove and properly discard all temporary labels and packaging material from the appliance. Remove all cardboard, zip ties, paper and plastic sheathing used as packaging.
- Before leaving your residence, the installer should complete the Performance Checklist found at [www.bluestarcooking.com](http://www.bluestarcooking.com) or the last page of this manual. The Performance Checklist serves as your product registration.

# USE AND CARE

## GUIDE TO THE INDUCTION COOKTOP

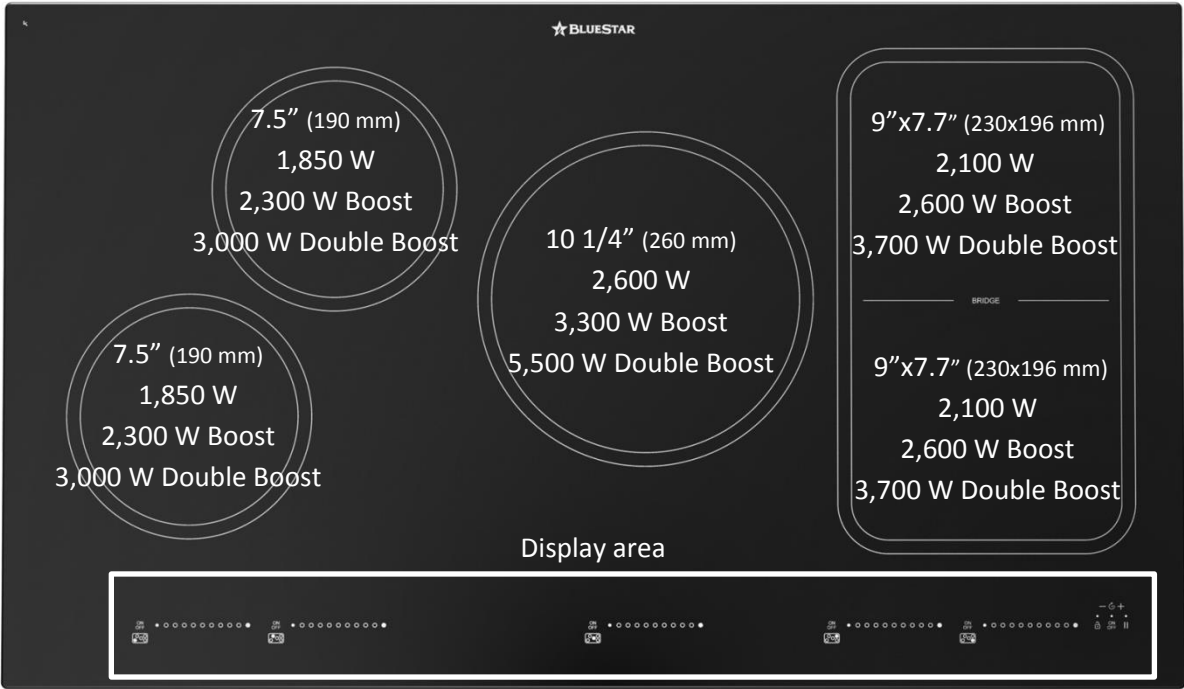

**Maximum Total Power 11,100 W**

Heat zone Location	Diameter	Nominal Power*	Boost*	Double Boost*	Mini-Detection Diameter
Front left	7.5" (190 mm)	1,850 W	2,300 W	3,000 W	4" (100 mm)
Rear Left	7.5" (190 mm)	1,850 W	2,300 W	3,000 W	4" (100 mm)
Center	10 1/4" (260 mm)	2,600 W	3,300 W	5,500 W	4 1/3" (110 mm)
Rear Right	9"x7.7" (230x196 mm)	2,100 W	2,600 W	3,700 W	4 1/3" (110 mm)
Front Right	9"x7.7" (230x196 mm)	2,100 W	2,600 W	3,700 W	4 1/3" (110 mm)

\*The stated power may change according to the dimensions and material of the pan.

## CONTROL PANEL & DISPLAY

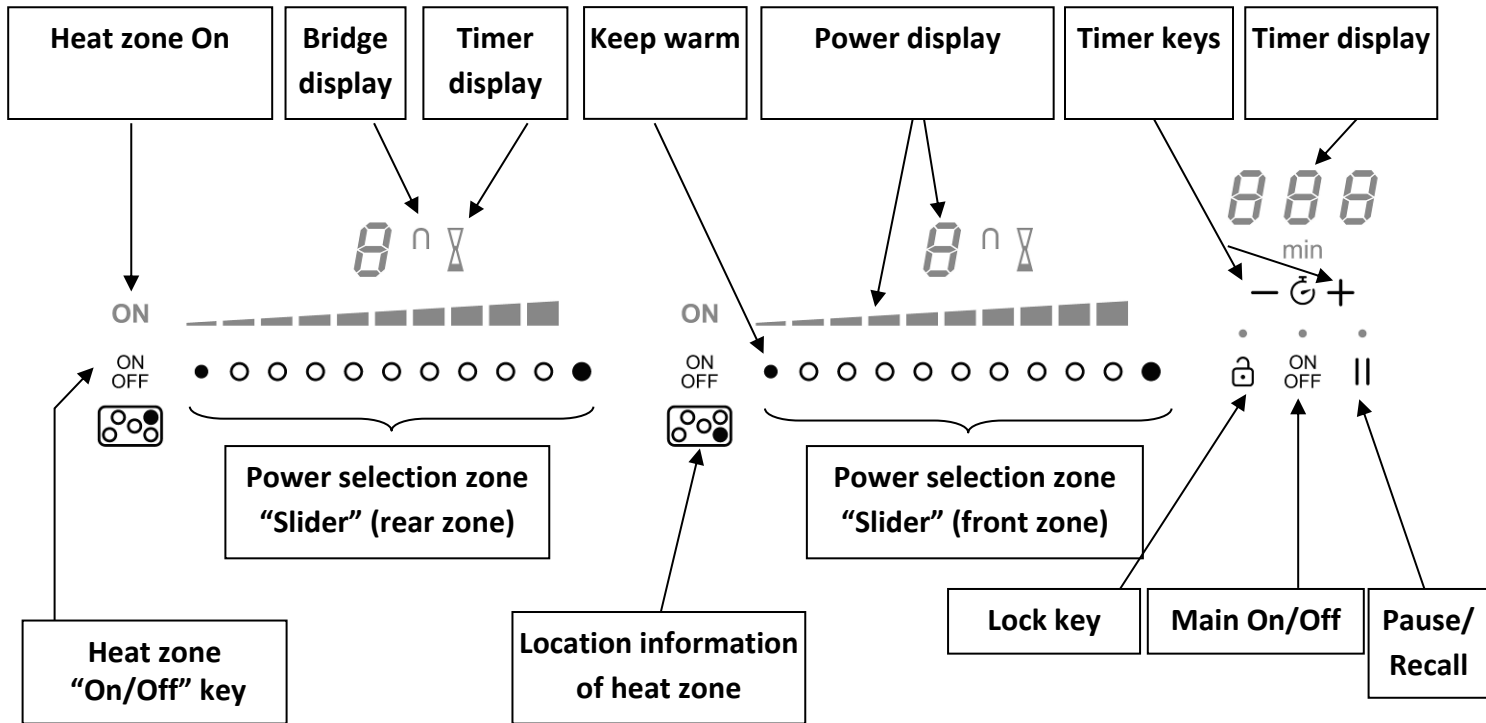

Display	Designation	Description
	Cooking level	Selection of the cooking level.
	No pan detected	No pan or inadequate pan
	Boost	Boost is activated
	Double Boost	Double Power Boost is activated
	Heat accelerator	Automatic cooking
	Keep warm	Automatically maintain choice of 107.6°F, 158°F, or 201.2°F
	Stop & Go	The unit is paused
	Residual heat	The indicated heat zone is hot
	Lock	Unit is locked
	Error message	Electronic failure

## BEFORE YOU BEGIN

### Clean the Cooktop

Remove and properly discard all temporary labels and self-adhesives from the ceramic glass.

- Clean your cooktop with a damp cloth, and then dry the surface thoroughly.

 **WARNING** Do not use detergent; this can create a blue-tinted color on the glass surface.

### Cookware Compatibility

 **WARNING** The cookware must be induction compatible.

Any **ferromagnetic pan is recommended**. You can check this with a magnet. If the magnet adheres to the pot, the pot is likely to be induction compatible. Compatible pots are usually cast iron, steel, enameled, and stainless-steel pans with ferromagnetic bottoms.

 **WARNING** **Excluded materials** include copper, pure stainless-steel, aluminum, glass, wood, ceramic, and stoneware.

When purchasing cookware, select those labelled for induction use or that have the induction compatible logo.

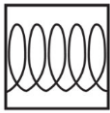

Induction

The induction heat zones automatically adapts to the size of the pan. If the pot diameter is too small, the cooktop will not work. The minimum diameter varies based on the heat zone diameter.

If the pan is not adapted for the induction cooktop, the display will show .

## Cookware Flatness

For optimal efficiency, cookware should have flat bottoms.

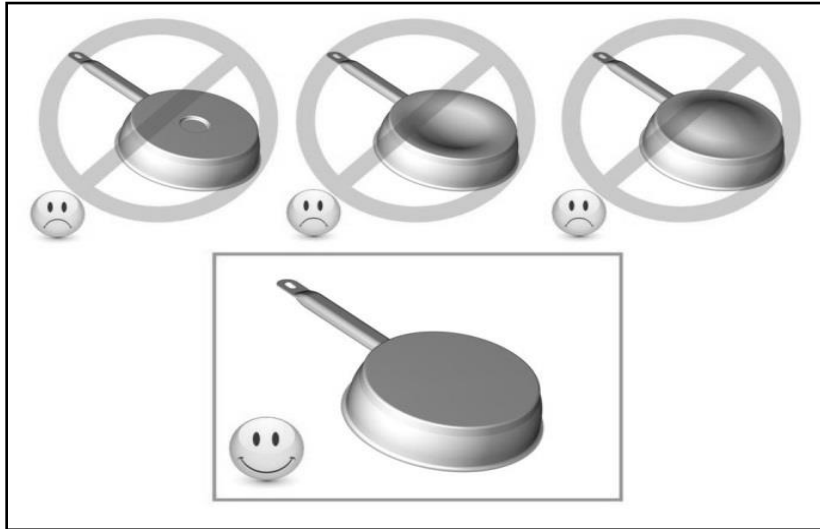

## Noise

Certain pans can make noise when they are placed on a heat zone. Some pans are noisier than others. When used at maximum power, the unit will become noisier. The pan will begin vibrating and the cooling fan will start.

### ATTENTION

This noise is normal, and does not mean that there is something wrong with the appliance, nor does it influence its function.

## Cooling Fan

- The cooling system is fully automatic. It starts at a low speed when the heat generated by the electronic system reaches a certain level.
- The fan cycles to its highest speed when the cooktop is intensively used.
- The cooling fan reduces its speed and stops automatically when the electronic circuit has cooled down enough.

## OPERATING THE TOUCH INDUCTION COOKTOP

Your appliance is equipped with electronic controls with sensitive touch keys. When your finger presses the key, the corresponding command is activated. This activation is validated by a control light, a letter or a number in the display and/or a “beep” sound.

Power selection zone “SLIDER” and timer setting zone

To select the power level, slide your finger left or right on the “SLIDER”. You can also directly choose a power level by pressing the specific power level, shown below in direct access.

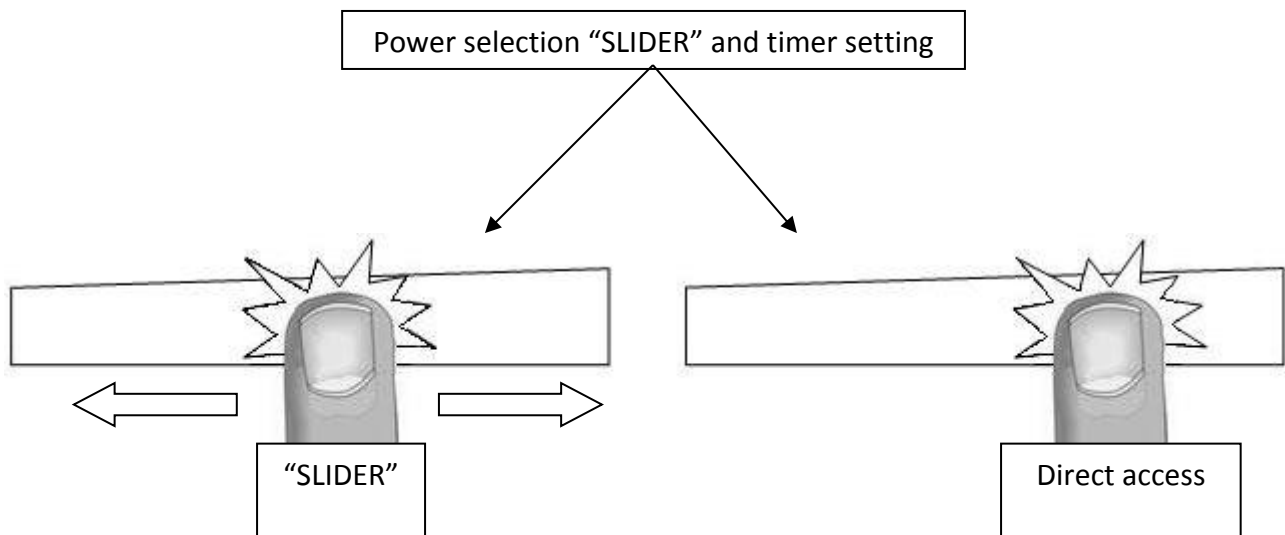

## TURNING THE COOKTOP ON/OFF

<u>Action</u>	<u>Control panel</u>	<u>Display</u>
To start	press [ main On/Off ] key	[ 0 ]
To stop	press [ main On/Off ] key	nothing or [ H ]

## TURNING A HEAT ZONE ON

<u>Action</u>	<u>Control panel</u>	<u>Display</u>
Select heat zone	Press heat zone “On/Off” key	[ ON ]
To set (adjust the power)	move the “SLIDER” to the right or to the left	[ 1 ] to [ P ]
To stop	slide to [ 0 ] on “SLIDER”	[ 0 ] or [ H ]

If no pan makes contact with the surface in 20 second the electronics returns to waiting.

## PAN DETECTION

The cooktop will not warm:

- If there is no pan on the heat zone or if this pan is not compatible with induction. Without a pan it is not possible to increase the power and the display will show [ U ]. This symbol disappears when a pan is put on the heat zone.
- If the pan is removed from the heat zone the operation is stopped. The heat zone will display [ U ]. The symbol [ U ] disappears when the pan is put back to the heat zone. The cooking continues with the power level set before.

### ATTENTION

**After use, switch the heat zone OFF, don't let the pan detection [ U ] active.**

## RESIDUAL HEAT INDICATION

After the heat zone or the Main switch is turned OFF the heat zones will still be hot and the cooktop will indicate [ H ] on the display.

The symbol [ H ] disappears when the heat zones have been cooled and can be touched.

### WARNING

**When the residual heat indicators [ H ] are illuminated do not touch the heat zones or not put any heat sensitive objects on them. Risks of burn and fire are possible.**

## BOOST AND DOUBLE BOOST FUNCTION

Boost [ P ] and Double Boost [  ] supply additional power to the selected heat zone.

If this function is activated the heat zones will work for 10 minutes with additional power.

### TIP

This is perfect for a rapid boil of water or a high heat sear.



## START / STOP BOOST

<u>Action</u>	<u>Control panel</u>	<u>Display</u>
Turn on heat zone	Press heat zone "On/Off" key	[ ON ]
Start Boost	Slide finger from left to right at the end of the "SLIDER" Or directly press the end of the "SLIDER"	[ P ]
Stop Boost	Slide finger from right to left at the end of the "SLIDER" Or directly press the front of the "SLIDER"	[ 9 ] to [ 0 ]

## START / STOP DOUBLE BOOST

<u>Action</u>	<u>Control panel</u>	<u>Display</u>
Switch on heat zone	Press heat zone "On/Off" key	[ ON ]
Start up the Boost	Slide to the end of the "SLIDER" Or press directly on the end of the "SLIDER"	[ P ]
Start up Double Boost	Re-press key [ P ]	[  and P ]
Stop the Double Boost	Slide on the "SLIDER"	[ P ] to [ 0 ]
Stop Boost	Slide on the "SLIDER"	[ 9 ] to [ 0 ]

## POWER MANAGEMENT

There is a maximum amount of power across the entire cooktop. When the Boost or Double Boost power level is selected on a specific heat zone the electronic system automatically reduce the power level of other heat zones. The display will blink on [ 9 ] for a few seconds and then display the maximum amount of power available.

An example at Boost Level 9:

Boost heat zone selected [ P ] is displayed      Other heat zones: [ 9 ] goes to [ 6 ] or [ 8 ] depending the type of heat zone

## SETTING/MODIFYING COOK TIMERS

A timer is able to be used simultaneously on each individual heat zone and with different time settings. Settings are available from 0 to 999 minutes for each heat zone.

<u>Action</u>	<u>Control panel</u>	<u>Display</u>
Switch on heat zone	Press heat zone "On/Off" key	[ ON ]
Select the power level	slide on the "SLIDER"	[ 1 ] to [ P ]
Select the Timer	Simultaneously press [ - ] and [ + ]	Timer will display on
Decrease the time	Press [ - ] key to decrease time	[ 60 ] to 59, 58...
Increase the time	Press [ + ] key to add time	Time increases

After a few seconds, the [ min ] display stops with blinking.  
The time is confirmed and the timer starts.

### STOPPING COOK TIMERS

<u>Action</u>	<u>Control panel</u>	<u>Display</u>
Select the Timer	Simultaneously press [ - ] and [ + ] from the timer until the desired display is on	Timer display on
Stop the time	Press [ - ] key until 0	[ 000 ]

If several timers are activated, repeat the process.

### COOK TIME ENDS

As soon as the selected cooking time is finished the timer displays blinking [ 000 ] and a buzzer/beep sounds.

To stop the sound and the blinking, simultaneously press the [ - ] and [ + ] key.

### STARTING EXTERNAL/INDEPENDENT TIMER

The external timer operates independently from the individual heat zone timers.

If the external timer is on and the cooktop is switched off, the timer will continue until time runs out.

<u>Action</u>	<u>Control panel</u>	<u>Display</u>
Turn on cooktop	Press [ main On/Off ] key	[ 0 ]
Select the Timer	Simultaneously press [ - ] and [ + ]key for the timer	[ 000 ]
Decrease the time	Press [ - ] key to decrease time	[ 60 ] to 59, 58...
Increase the time	Press [ + ] key to add time	Time increases

After a few seconds, the [ min ] display stops with blinking.  
The time is confirmed and the timer starts.

### STARTING AUTOMATIC COOKING

All the heat zones are equipped with an automatic cooking device. The heat zone can start at full power, and then reduce automatically to a pre-selected power level.

<u>Action</u>	<u>Control panel</u>	<u>Display</u>
Switch on heat zone	Press heat zone "On/Off" key	[ ON ]
Power level selection	slide on the "SLIDER" to [ 7 ] (for example « 7 ») and hold for 3secs	[ 7 ] is blinking with [ A ]

## ENDING AUTOMATIC COOKING

<u>Action</u>	<u>Control panel</u>	<u>Display</u>
Power level selection	slide on the "SLIDER"	[ 0 ] to [ 9 ]

## STOP & GO FUNCTION

This function temporarily suspends all heat from the heat zones and then allows heat zones to restart with the same settings.

<u>Action</u>	<u>Control panel</u>	<u>Display</u>
Start pause	press [ II ]	[ II ] and control light on
Stop pause	press [ II ] Press on the animated "slider"	"Slider" animated Previous settings

## RECALL FUNCTION

After switching off the cooking (press main On/Off key), it is possible to recall the last settings.

- Cook settings on all heat zones
- Minutes of programmed heat zone-related timers
- Keep warm function
- Automatic cooking

The activate recall functionality:

- Press [ main On/Off ] key
- Then press [ II ] before the light stops blinking.



The previous settings are again active.

## STARTING "KEEP WARM" FUNCTION

This function automatically maintains one of three temperature settings: 107.6°F, 158°F or 201.2°F.

**TIP**

This is perfect for entertaining and will avoid liquids from overflowing or scorching or burning sauces.

<u>Action</u>	<u>Control panel</u>	<u>Display</u>
Switch on heat zone	Press heat zone "On/Off" key	[ ON ]
Select 107.6°F	Press [Keep warm ] key	[  ]
Select 158°F	Press & hold [Keep warm ] key 2secs	[  ]
Select 201.2°F	Press & hold [Keep warm ] key 4secs	[  ]
To stop	Slide on the "SLIDER" or press [Keep warm ] key until [ 0 ]	[ 0 ] to [ 9 ] [ 0 ]

The Keep Warm function is only available for a maximum of 2 hours.

## BRIDGE FUNCTION

This function allows the use of two heat zones (far right square heat zones) to operate with the same features as a single heat zone. Boost function is not possible when using the Bridge function.

<u>Action</u>	<u>Control panel</u>	<u>Display</u>
Turn on cooktop	Press [ main On/Off ] key	[ 0 ]
Switch on both heat zones	Press heat zone "On/Off" key	[ ON ]
Activate the bridge	Simultaneously press on the "Slider" of both heat zones	[ 0 ] and [  ]
Increase bridge	Slide on the "SLIDER" will indicate power level	[ 1 ] to [ 9 ]
Stop the bridge	Simultaneously press on the "Slider" of both heat zones	[ 0 ]

## CONTROL PANEL LOCKING

To avoid turning on or modifying heat zones, particularly during cleaning, the control panel can be locked (with exception to the main On/Off key).

<u>Action</u>	<u>Control panel</u>	<u>Display</u>
Locking the cooktop	Press [ Lock ] key & hold for 6secs	Locking light on
Unlocking the cooktop	Press [Lock ] key & hold for 6secs	Locking light off

## GUIDE TO HEAT ZONE POWER SETTINGS



1 to 2	Melting Reheating	-Sauces, butter, chocolate, gelatin -Dishes prepared beforehand
2 to 3	Simmering Defrosting	-Rice, pudding, simple syrup -Dried vegetables, fish, frozen products
3 to 4	Steam	-Vegetables, fish, meat
4 to 5	Water	-Steamed potatoes, soups, pasta, fresh vegetables
6 to 7	Medium cooking Braising	-Meat, eggs, sausages -Stews
7 to 8	Cooking	-Potatoes, fritters
9	Frying, searing Boiling water	-Steaks, fried dishes -Water
P &  	Frying, roasting Boiling water	-Scallops, steaks -Boiling large amount of water

## OPERATING THE INDUCTION COOKTOP

### Residual Heat Indicator



Although the cooking surface is not producing any heat, the hot bottoms of cookware will conduct heat to the glass. After cooking, the heat zones will remain hot. **There are risks of burns and fire.**

- Heat sensors are located underneath the cooking surface.  will display on the heat zones that remain hot.
- The  disappears when the heat zones can be touched without danger.



**Do not touch the heat zones and do not put any heat sensitive objects on them when the residual heat indicators are on.**

### Error Message



If the malfunction light **E** is displayed, the cooktop is malfunctioning. Turn off or disconnect appliance from power supply. Contact a qualified technician for service.

## CARE

### ATTENTION

**Follow these guidelines to prevent personal injury or damaging your induction cooktop:**

- Raw cookware like cast iron (not enameled cast iron) or damaged cookware may damage the ceramic glass.
- Gritty or other abrasive materials may damage the ceramic glass.
- Avoid dropping objects, even little ones, on the ceramic glass cooktop.
- Make sure that the ventilation of the appliance works according to the manufacturer's instructions.
- Do not put or leave empty saucepans on the cooktop.
- Sugar, synthetic materials, or aluminum sheets must not come in contact with the heat zones. These materials may crack or alter the ceramic glass cooktop while cooling. Turn off the appliance and take them immediately out of the hot heat zone (be careful: do not burn yourself).
- Never place a hot container on the control panel.
- Drawers installed beneath the induction cooktop must be heat-resistant.
- If a drawer is located underneath the installed appliance, make sure the space between the contents of the drawer and the lower part of the appliance is large enough (1 inch / 2 cm) to guarantee correct ventilation.
- Never place or store flammable objects (e.g., aerosol sprays) into the drawer located beneath the cooktop.



### WARNING

**Fire Danger - Do not store items on the cooking surface.**

## CLEANING



### WARNING

**Turn the Induction cooktop off and make sure it is cool before cleaning.**

- To avoid a risk of a burn, do not clean the cooktop when the glass is hot and the Residual Heat (H) indicator is lit.
- Remove small spots with a damp cloth using dishwashing liquid diluted in a little water, then rinse with cold water and dry the surface thoroughly.
- Never use a steam cleaner or high-pressure washer.
- Do not use objects that might scratch the ceramic glass.
- Make sure the cookware is dry and clean, and there is no dust on your ceramic cooktop. Using rough cookware will scratch the surface.
- Spillages of sugar, jam, jelly, etc. or other sugar-based food products must be removed immediately to prevent damaging the surface.

### ATTENTION

Avoid highly corrosive or abrasive detergents and cleaning supplies. These are likely to cause scratches and damage the cooktop.

## TROUBLESHOOTING

Check these helpful knots for any problems with your cooktop. If you need additional help call BlueStar® Customer Service at 800-449-8691.

PROBLEM	POSSIBLE CAUSE	SOLUTION
The cooktop or the heat zones does not start.	<ul style="list-style-type: none"> <li>• The cooktop has a poor connection to the electrical network.</li> <li>• The safety fuse is cut off.</li> <li>• The lock function is activated.</li> <li>• The sensitive touch keys are covered with grease or water.</li> <li>• An object is placed on a sensitive touch key.</li> </ul>	
One or all of the heat zones are not operating.	<ul style="list-style-type: none"> <li>• The safety system (lock) is engaged.</li> <li>• The safety system automatically engages if the heat zones isn't turned off.</li> <li>• One or more sensitive touch keys are covered.</li> <li>• The pot or pan is empty and its bottom overheated.</li> <li>• The cooktop automatically reduced the power level (see Boost function) and turned off to prevent overheating.</li> </ul>	
The display area shows [ <u> </u> ]	<ul style="list-style-type: none"> <li>• There is no cookware on the heat zones.</li> <li>• The cookware is not compatible with induction.</li> <li>• The cookware's base diameter is too small.</li> </ul>	
The display area shows [ E ]	<ul style="list-style-type: none"> <li>• The electrical system is defective.</li> </ul>	<ul style="list-style-type: none"> <li>• Disconnect and reconnect the cooktop.</li> <li>• Call service.</li> </ul>
The cooling fan is still operating after switching off the cooktop.	<ul style="list-style-type: none"> <li>• This is not a failure. The fan operates automatically to protect the electronic device.</li> </ul>	<ul style="list-style-type: none"> <li>• The fan stops automatically.</li> </ul>
The Heat Accelerator does not start.	<ul style="list-style-type: none"> <li>• The heat zone is still hot [ H ].</li> <li>• The highest Boost level is set [ 9 ].</li> </ul>	
The display area shows [ U ] or [ u ].	<ul style="list-style-type: none"> <li>• See the Keep Warm function section</li> </ul>	
The display area shows [  ] or [ Er03 ].	<ul style="list-style-type: none"> <li>• An object or liquid covers the controls.</li> </ul>	
The display area shows [ E2 ]	<ul style="list-style-type: none"> <li>• The cooktop is overheated.</li> </ul>	<ul style="list-style-type: none"> <li>• Allow the cooktop to cool.</li> </ul>
The display area shows [ E8 ]	<ul style="list-style-type: none"> <li>• The air inlet of the ventilator is obstructed.</li> </ul>	<ul style="list-style-type: none"> <li>• Remove the obstruction.</li> </ul>
The display area shows [U400]	<ul style="list-style-type: none"> <li>• The cooktop is not connected to the electrical network.</li> </ul>	<ul style="list-style-type: none"> <li>• Check the connection and reconnect the cooktop.</li> </ul>
The display area shows [Er47]	<ul style="list-style-type: none"> <li>• The cooktop is not connected to the electrical network.</li> </ul>	<ul style="list-style-type: none"> <li>• Check the connection and reconnect the cooktop.</li> </ul>
The display area shows [ II ]	See the Stop & Go section	



## PERFORMANCE CHECKLIST

This checklist has been developed to assure proper installation of your appliance.

To validate your warranty you must mail or submit online this form within 90 days of installation and a copy of your receipt to: Warranty Department, Prizer-Painter Stove Works Inc., 318 June Avenue Blandon, PA 19510 or [www.bluestarcooking.com/support/product-registration/](http://www.bluestarcooking.com/support/product-registration/).

### Customer Information (Please Print)

Name: \_\_\_\_\_

Address: \_\_\_\_\_

City: \_\_\_\_\_

State, Zip Code: \_\_\_\_\_

E-mail: \_\_\_\_\_

Telephone: \_\_\_\_\_

Dealer: \_\_\_\_\_

### Product Information (Please Print)

Model No: \_\_\_\_\_

Serial No: \_\_\_\_\_

Purchase Date: \_\_\_\_\_

Installation Date: \_\_\_\_\_

Installer's Name: \_\_\_\_\_

Company: \_\_\_\_\_

Telephone: \_\_\_\_\_

### CHECK ALL THAT APPLY

#### Appearance and Aesthetics

- Exterior
- Top Section

#### Installation

- Proximity to cabinets
- Level
- Ventilation system
- Read User Manual
- Review safety instructions

#### Electrical Connection

- Correct voltage
- Grounded outlet
- Polarized outlet
- No GFCI

#### Controls

- Thermostats

## LIMITED WARRANTY

### BlueStar® Cooking Appliances, BlueStar® Ventilation Hoods, Prizer Hoods® Ventilation Hoods and Abbaka Ventilation hoods and remote blowers

Before using your Product, please read this Limited Warranty and Arbitration Clause carefully to understand your rights.

This Warranty is provided to you by Prizer-Painter Stove Works, Inc. (“Prizer-Painter”), which warrants the parts of your BlueStar® cooking appliance, BlueStar® ventilation hood, Prizer Hoods® ventilation hood, or Abbaka ventilation hood or remote blower (“Product”), as described below.

This Warranty covers the owner of the residence in which the Product is installed, and his or her spouse (“Owner” or “You”).

#### **Products Covered**

This Warranty applies only to BlueStar® cooking appliances, BlueStar® ventilation hoods, Prizer Hoods® ventilation hoods and Abbaka ventilation hoods and remote blowers purchased in the continental U.S. and Canada on or after April 1, 2019. This Warranty applies only to Product sold by a BlueStar® authorized dealer or Prizer-Painter directly for use in residential properties only. Products must be installed by a qualified, licensed installer. Any service call deemed to be the result of improper installation shall be the responsibility of the owner. This Warranty is also void if the original factory installed serial number is altered or removed from the Product.

#### **Products Not Covered**

This Warranty does not apply to Products installed or used in any commercial or other non-residential property such as, but not limited to, day care facilities, hotels, motels, firehouses and nursing homes. This Warranty does not cover Products installed outside the U.S. or Canada. This Warranty does not apply to gas type conversions on cooking appliances not completed by a certified gas technician, licensed plumber or certified BlueStar® servicers.

#### **Full Two-Year Warranty**

Product Registration is not required to obtain Warranty Coverage but is highly recommended for optimal servicing and affects the length and certain remedies available under the warranty.

If the Product is properly registered within 90 days of Installation Date: For two (2) years from the date that the Product is originally installed, this Warranty covers all parts and labor to repair or replace, at our discretion, any functional component of the Product, that is defective in materials or workmanship. Replacement service will only be provided if and when attempts to repair the Product have been exhausted. Such repair or replacement service must be performed by a factory authorized service agent located within 100 miles roundtrip from the location of the Product. Service will be provided during normal business hours. The Owner will be responsible for any and all costs associated with additional mileage, non-standard service or overtime, and special equipment required to remove the Product so

that service may be performed. Prizer-Painter reserves the right to deny warranty coverage for excessive installation delays.

For products not properly registered: For one (1) year from the date that the Product is originally installed, this Warranty covers all parts and labor to repair or replace, at our discretion, any functional component of the Product, that is defective in materials or workmanship. Replacement service will only be provided if and when attempts to repair the Product have been exhausted. Such repair or replacement service must be performed by a factory authorized service agent located within 100 miles roundtrip from the location of the Product. Service will be provided during normal business hours. The Owner will be responsible for any and all costs associated with additional mileage, non-standard service or overtime, and special equipment required to remove the Product so that service may be performed. Prizer-Painter reserves the right to deny warranty coverage for excessive installation delays.

**Limited Cosmetic Component Warranty:** This Warranty covers the repair or replacement of all cosmetic component flaws for thirty (30) calendar days from the date of delivery of the Product to the owner's home from a BlueStar® authorized dealer. Cosmetic components include top grates, ring grates, plate rail, kick panel, body sides, glass, control panel, door panel, back guards, oven seals, front sides of hoods, and hoods strapping. Cosmetic components flaws include visible chips, scratches, dents, provided, however, that cosmetic flaws caused by freight damage are excluded.

**Limited Warranty on Floor Models Not Used For Demonstration:** Floor Models are covered by a one (1) year limited functional parts and related services warranty, with proof of date of installation. There is no cosmetic warranty of any kind for floor models.

**Limited Warranty on Floor Models Used For Demonstration:** Floor Models used for demonstration are covered by a ninety (90) day limited parts warranty only, with proof of date of installation. There is no service or cosmetic warranty of any kind for floor models.

#### **Limited Warranty on Product Refurbished**

Refurbished Products are covered by a six (6) months limited functional parts and labor warranty, with proof of installation, as well as an additional six (6) months limited parts warranty. There is no cosmetic warranty of any kind on Refurbished Product.

#### **Registration**

Registration is strongly recommended. While not necessary to effectuate warranty coverage, it is the best way for Prizer-Painter to communicate with you about important events and also provides additional warranty coverage. TO REGISTER, please fill out the "Performance Checklist and Warranty Form" located online at [www.bluestarcooking.com/support/product-registration](http://www.bluestarcooking.com/support/product-registration). Or mail the form located in the back of the Product Use and Care Manual to: Warranty Department, Prizer-Painter Stove Works, 318 June Avenue, Blandon, PA 19510-9566.

#### **Obtaining Warranty Service**

If a Warranty claim is not submitted as required, such claim will be invalid and will not be honored.

To obtain Warranty service, where applicable, the Owner must call the Service Center (toll free: 1-800-449-8691) or fill out the online form at [www.bluestarcooking.com/service](http://www.bluestarcooking.com/service) to report a warranty claim, and may be required to, at the time, provide (1) the model number of the Product, (2) the serial number of the Product, (3) proof of delivery, (4) a signed installation receipt, (5) a description of the claimed defect, and (6) proof of purchase of the Product, including the original retail receipt or invoice to establish the Warranty Period. Prizer-Painter must be given an opportunity to inspect any Product subject to a warranty claim. All warranty related service repairs must be performed by a factory authorized service agent.

This Limited Warranty gives you specific legal rights, and you may also have other rights that may vary from state to state or province to province.

### **Out of Warranty Product**

Prizer-Painter is under no obligation, at law otherwise, to provide you with any concessions, including repairs, pro-rates or Product replacement, once this warranty has expired.

### **What Is Not Covered**

This Warranty does not cover, and specifically excludes:

- Damages caused by shipping.
- Damage or repairs to the porcelain igniters, calibrations and normal adjustments after installation and setup, including burner adjustments.
- Normal wear and tear, care, and maintenance of the Product as described in the installation and operating manual, such as cleaning of parts, discoloration of the griddle, rust, gasket materials, ceramic materials, and fuses.
- Damage or repairs caused by alterations or modifications, abuse, excessive force, misuse, neglect, or improper installation, instruction, handling, operation, maintenance or storage.
- Accidental or intentional damage.
- Damage or repairs caused by unauthorized or improper service or repairs.
- Damages or repairs as a result of natural disasters, fires, floods, earthquakes, winds, lightning, corrosive atmosphere, loss of electrical power to the Product for any reason, or other conditions beyond Prizer-Painter's control.
- Damage or repairs caused by alteration for outdoor use.
- Damage or repairs caused by the use of harsh chemicals or cleaning products improperly applied.
- Discolorations to backguards from use of griddle or burners.
- The replacement of a part or Product under this Warranty does not extend the Warranty period.
- If the Product is removed from the property where it was originally installed .
- Slight color variations may be noticed because of differences in painted parts, kitchen lighting, product placement, and other factors; this warranty does not apply to color variations.
- Service calls to educate the customer on proper use and care of the product.

- Failure of the product when used for commercial, business, rental or any application other than for residential consumer use.
- Liability or responsibility for damage to surrounding property including cabinetry, floors, ceilings and other structures or objects around the Product.
- Consequential or incidental damage, including but not limited to food or medicine loss, time away from work or restaurant meals.

This warranty is in lieu of all other express warranties. No employee or representative of Prizer-Painter is authorized to make any modification, extension or addition to this Limited Warranty.

**ALL IMPLIED WARRANTIES, INCLUDING BUT NOT LIMITED TO WARRANTIES OF MERCHANTABILITY AND FITNESS FOR PARTICULAR PURPOSE ARE LIMITED TO THE DURATION OF THIS WARRANTY.** Some states and provinces do not allow limitations on implied warranties, so the above limitation may not apply to you.

**THE OWNER AND PRIZER-PAINTER AGREE THAT THE REMEDIES SET OUT HEREIN ARE THE OWNER'S EXCLUSIVE REMEDIES FOR BREACH OF ALL WARRANTIES, EXPRESS OR IMPLIED.**

**WHETHER ANY CLAIM IS BASED ON NEGLIGENCE OR OTHER TORT, BREACH OF WARRANTY OR BREACH OF CONTRACT, OR ANY THEORY, PRIZER-PAINTER SHALL IN NO EVENT BE LIABLE FOR INCIDENTAL, CONSEQUENTIAL OR SPECIAL DAMAGES, INCLUDING BUT NOT LIMITED TO DAMAGES FOR EXPENSES, SUCH AS, EXTRA UTILITY EXPENSES, SHIPPING COSTS RELATED TO REPAIR OR REPLACEMENT OF ANY PRODUCT OR DAMAGES TO PROPERTY, RESULTING FROM BREACH OF THIS WARRANTY OR ANY IMPLIED WARRANTY.** Some states and provinces do not allow the exclusion or limitation of incidental or consequential damages, so these provisions may not apply to you.

**Where Can Any Legal Remedies Be Pursued**

Please see the Arbitration Clause and Related Provisions, which affect your legal rights. [Read this Arbitration Clause](#) and its related provisions carefully. The Arbitration Clause is also available on Prizer-Painter's

For further information about this warranty,  
contact Prizer-Painter Customer Service at 1-800-449-8691

## **ARBITRATION CLAUSE**

**BlueStar® Cooking Appliances, BlueStar® Ventilation Hoods, Prizer Hoods® Ventilation Hoods and Abbaka Ventilation Hoods and remote blowers**

**ARBITRATION CLAUSE. IMPORTANT. PLEASE REVIEW THIS ARBITRATION CLAUSE. IT AFFECTS YOUR LEGAL RIGHTS. YOU SHOULD ALSO CONSIDER CONSULTING WITH OTHERS ABOUT ARBITRATION BECAUSE THE INFORMATION PROVIDED IS NOT INTENDED TO CONTAIN A COMPLETE EXPLANATION OF THE CONSEQUENCES OF ARBITRATION.**

1. Parties: This arbitration clause affects your rights against Prizer-Painter Stove Works, Inc. and any of its affiliates or employees or agents, successors, or assigns, all of whom together are referred to as “we” or “us” for ease of reference.

**2. ARBITRATION REQUIREMENT: EXCEPT AS STATED BELOW, ANY DISPUTE BETWEEN YOU AND ANY OF US SHALL BE DECIDED BY NEUTRAL, BINDING ARBITRATION RATHER THAN IN COURT OR BY JURY TRIAL.** “Dispute” will be given the broadest possible meaning allowable by law. It includes any dispute, claim, or controversy arising from or relating to your purchase of a Prizer-Painter Product, any warranty upon the unit, or the unit’s condition. The arbitrator(s) shall have the exclusive power and jurisdiction to make all procedural and substantive decisions concerning the Dispute including the power to determine the question of arbitrability including the scope or applicability of this Arbitration Clause. The arbitration requirement applies to all claims including those arising out of contract and tort, pursuant to statute, or otherwise.

**3. CLASS-ARBITRATION WAIVER: ARBITRATION IS HANDLED ON AN INDIVIDUAL BASIS. IF A DISPUTE IS ARBITRATED, YOU AND WE EXPRESSLY WAIVE ANY RIGHT TO PARTICIPATE AS A CLASS REPRESENTATIVE OR CLASS MEMBER ON ANY CLASS CLAIM YOU MAY HAVE AGAINST US, AND US AGAINST US, OR AS A PRIVATE ATTORNEY GENERAL OR IN ANY OTHER REPRESENTATIVE CAPACITY. YOU AND WE ALSO WAIVE ANY RIGHT TO CLASS ARBITRATION OR ANY CONSOLIDATION OF INDIVIDUAL ARBITRATIONS.**

4. Discovery and Other Rights: Discovery and rights to appeal in arbitration are generally more limited than in a lawsuit. This applies to both you and us. Other rights that you or we would have in court may not be available in arbitration. Please read this Arbitration Clause and consult the rules of the arbitration organizations listed below for more information.

**5. SMALL CLAIMS COURT OPTION: YOU MAY CHOOSE TO LITIGATE ANY DISPUTE BETWEEN YOU AND ANY OF US IN SMALL CLAIMS COURT, RATHER THAN IN ARBITRATION, IF THE DISPUTE MEETS ALL REQUIREMENTS TO BE HEARD IN SMALL CLAIMS COURT.**

**6. OPTING OUT OF THIS ARBITRATION CLAUSE: YOU MAY OPT OUT OF THIS ARBITRATION CLAUSE WITHIN 60 DAYS OF WHEN WARRANTY COVERAGE BEGINS, IF YOU INFORM PRIZER-PAINTER IN WRITING, VIA REGISTERED MAIL (SENT TO PRIZER-PAINTER CONSUMER AFFAIRS , Prizer-Painter Stoveworks, 318 June Avenue Blandon, PA 19510-9566. THAT YOU ARE OPTING OUT.** Please also provide your name, address, product model and serial number and proof of purchase. There is no other procedure to opt out. Opting out of this Arbitration Clause will not affect your other rights under this warranty.

7. Governing Law: The procedures and effect of the arbitration clause will be governed by the Federal Arbitration Act (9 U.S.C. § 1 *et seq.*) rather than by state law concerning arbitration. The law governing your substantive warranty rights and other claims will be the law of the state in which you purchased your Prizer-Painter Product. Any court having jurisdiction may enter judgment on the arbitration award.

8. Rules of the Arbitration: If the amount in controversy is less than \$50,000, the arbitration will be decided by a single arbitrator to be appointed according to the rules of the arbitration association that is chosen. If the amount in controversy is greater than or equal to \$50,000, the arbitration will be decided by a panel of three arbitrators. The arbitrator(s) will be chosen pursuant to the rules of the administering arbitration organization. You may choose either of the following arbitration organizations, and its applicable rules: the American Arbitration Association, 1633 Broadway, 10th Floor, New York, NY 10019 ([www.adr.org](http://www.adr.org)), JAMS, 1920 Main Street, Ste. 300, Irvine, CA 92614 ([www.jamsadr.com](http://www.jamsadr.com)), or any other organization that you may choose subject to our approval. These organizations' rules can be obtained by contacting the organization or visiting its website. If the chosen arbitration organization's rules conflict with this Arbitration Clause, the provisions of this Arbitration Clause control. The award of the arbitrator(s) shall be final and binding on all parties.

9. Location of the Arbitration Hearing: Unless applicable law provides otherwise, the arbitration hearing will be conducted in the federal judicial district in which you reside.

10. Costs of the Arbitration: Each party is responsible for its own attorney, expert and other fees, unless awarded by the arbitrator(s) under applicable law. Prizer-Painter will pay your share of the fees charged by the arbitration organization and arbitrator(s) beyond the first \$200. Where permissible by law, you may be required to reimburse Prizer-Painter for the fees of the arbitration organization and arbitrator(s) in whole or in part by decision of the arbitrator(s) at the discretion of the arbitrator(s).

11. Survival and Enforceability of this Arbitration Clause: This Arbitration Clause shall survive the expiration or termination, or any transfer, of the warranty on your unit. If any part of this Arbitration Clause, except waivers of class-action rights, is found to be unenforceable for any reason, the remainder shall remain enforceable. If, in a case in which class-action allegations have been, a waiver of class-action rights is found to be unenforceable with respect to all or some parts of a dispute, the remainder of this Arbitration Clause shall be unenforceable as those parts. Instead, those parts will be severed and proceed in court, with the remaining parts proceeding in arbitration.

12. Confidentiality. The arbitrator(s), Prizer-Painter and Owner will maintain confidentiality of the proceedings including but not limited to all information gathered, prepared and presented for purposes of the arbitration relate to the Dispute.

13. Informal Process to Resolve Disputes. Our goal is to resolve claims fairly and quickly. For any Dispute that You have against Prizer-Painter, you agree to first contact Prizer-Painter and attempt to resolve the claim informally by sending written notice of your claim by email to [legal@bluestarcooking.com](mailto:legal@bluestarcooking.com). The notice must include (a) your name, address, email address and mobile telephone number; (b) describe the nature and basis of the Dispute; and (c) set forth the specific relief being sought. If You and Prizer-Painter cannot reach an agreement within thirty (30) days after such notice is received, then either party may submit this Dispute to binding arbitration as set forth above or where applicable to small claims court.