

BlueStar® has combined professional level features and handcrafted quality into the Culinary Series - Sealed Burner line. Cook like a pro with professional level power and versatility with 21,000 BTUs* of searing power plus a precise simmer burner. The new 48" Culinary Series - Sealed Burner features an extra-large convection oven that will accommodate a commercial size baking sheet plus a companion oven that accommodates a half size sheet pan. Create a custom design with your choice of 1,000+ colors, 10 metal trims and colored knobs.



PRODUCT FEATURES

- 8 sealed burners for maximum cooking area
- Powerful 21,000* BTU burners
- Precise 5,000 BTU simmer burner
- 2 over-sized ovens
- 30" convection oven fits commercial size sheet pans
- 1850° commercial-grade infrared broiler
- Available in 1,000 colors and finishes plus 10 metals trims
- Handcrafted in Pennsylvania since 1880

SPECIFICATIONS

Range Dimensions: 47.875"W x 24"D x 36.75"H
 Large Oven Interior: 23.25"W x 20"D x 15"H
 Small Oven Interior: 13.25"W x 20"D x 15"H
 Top Burner Rating: NAT 21,000 BTUs | LP 18,000 BTUs
 Simmer Burner Rating: 5,000 BTUs
 Large Oven Burner Rating: 30,000 BTUs
 Small Oven Burner Rating: 15,000 BTUs
 Infrared Broiler Rating: 15,000 BTUs
 Electrical Requirements: 120V, 60Hz, 15 AMPs, 1 PH
 (Unit must be on a Non-GFI, dedicated outlet)
 Operating Gas Pressure: NAT: 5.0" WC, LP: 10.0" WC
 Gas Line Size: 3/4"
 Installation Clearance: 0" Side Cabinet, 0" Back Wall

MODEL CONFIGURATION

Eight Burners

RCS48SBV2

BURNER CONFIGURATION

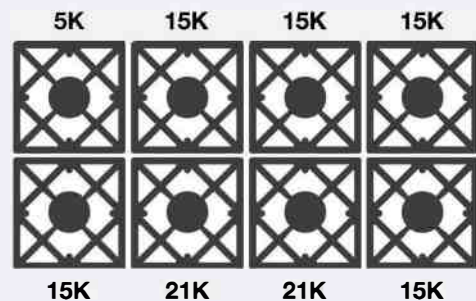

ADDITIONAL CUSTOMIZATION OPTIONS

- 1,000 colors and finishes
- 190 knob colors
- 10 metal trims
- Available with island trim and 6" backguard only

All specifications subject to change without notice. Visit www.bluestarcooking.com for most up to date information prior to installation or site preparation.

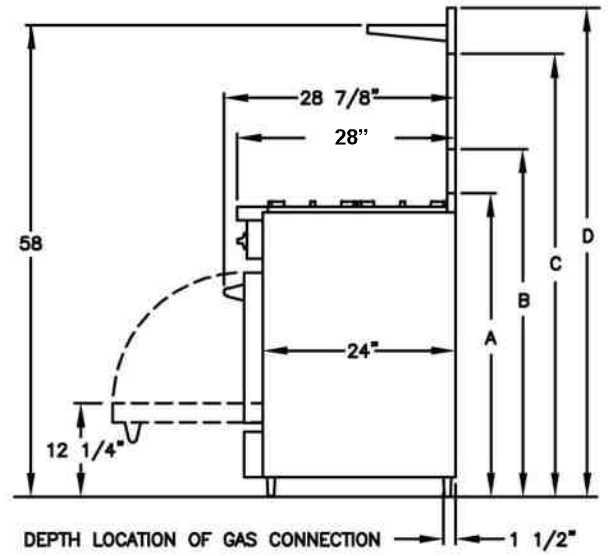
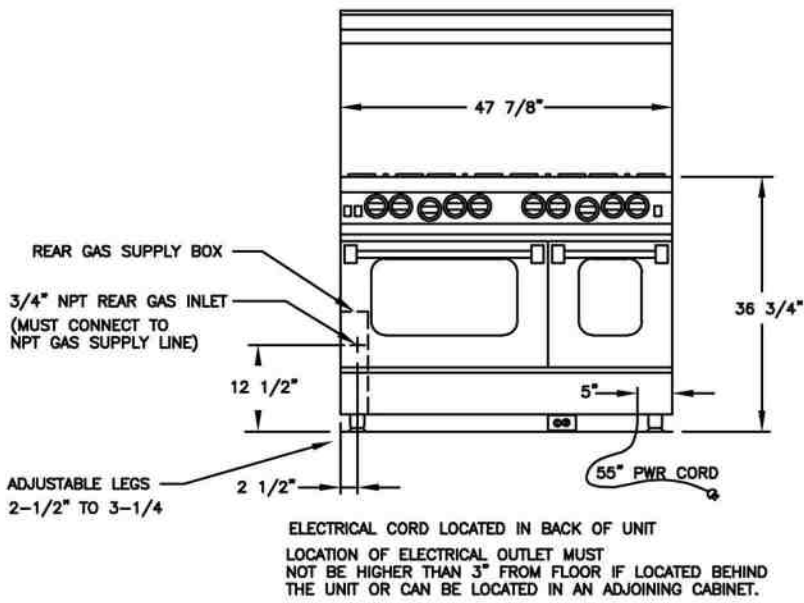

- A - ISLAND TRIM HEIGHT - 38 1/4"
- B - 6" STANDARD BACKGUARD HEIGHT - 43 1/4"
- C - 17" BACKGUARD HEIGHT - 54 1/4"
- D - HIGH SHELF BACKGUARD HEIGHT - 61"

RELATED PRODUCTS

VENTILATION

